

# MT2E

## Test Applications • Incremental Encoder

Compact String Pot • 30-inch Stroke Range  
 Dual Axis 360° Mounting Bracket  
 Flight/Crash Test Applications  
 Aluminum & Polycarbonate Enclosure



### GENERAL

Full Stroke Range	0-30 inches, min.
Output Signal	incremental encoder
Accuracy	0.04% full stroke (contact factory for higher accuracy)
Repeatability	± 0.02% full stroke
Resolution	316 ± 7 pulses per inch (13 ± 1 pulses per mm)
Measuring Cable	Ø.019-in. nylon-coated stainless steel
Enclosure Material	anodized aluminum
Sensor Cover	polycarbonate
Sensor	optical incremental encoder
Weight	0.5 lb. max.

### ELECTRICAL

Input Voltage	5 - 26 VDC
Input Current	35 mA, no load
Output Driver	push-pull, 20 mA source/sink
Output Voltage	equal to the input voltage
Mating Plug	LEMO FGG.OB.304.CLAD52

### MECHANICAL

Measuring Cable Tension Options	9, 14 and 33 oz.
Maximum Measuring Cable Acceleration	136 g

### ENVIRONMENTAL

Operating Temperature	32° to 158° F ( 0° to 70°C)
-----------------------	-----------------------------

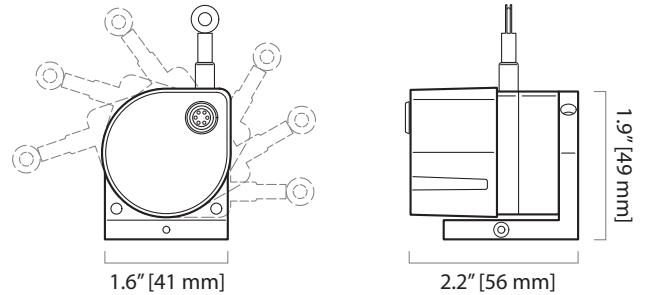

The MT2E is our new encoder-based member to our family of rugged, accurate miniature cable-extension position transducers. The Celesco MT2E features a highly-tensioned heavy-duty measuring cable that was designed for the high-acceleration demands encountered in flight testing and automotive crash tests.

The MT2E was designed with 2-axis 360° rotation in its mounting bracket which allows for fast and simple installation in any direction.

### Output Signal

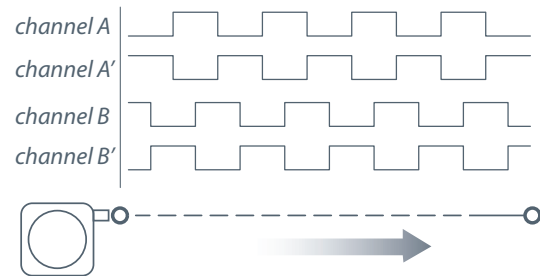

-- see ordering information for available channels

**Outline Drawing:**

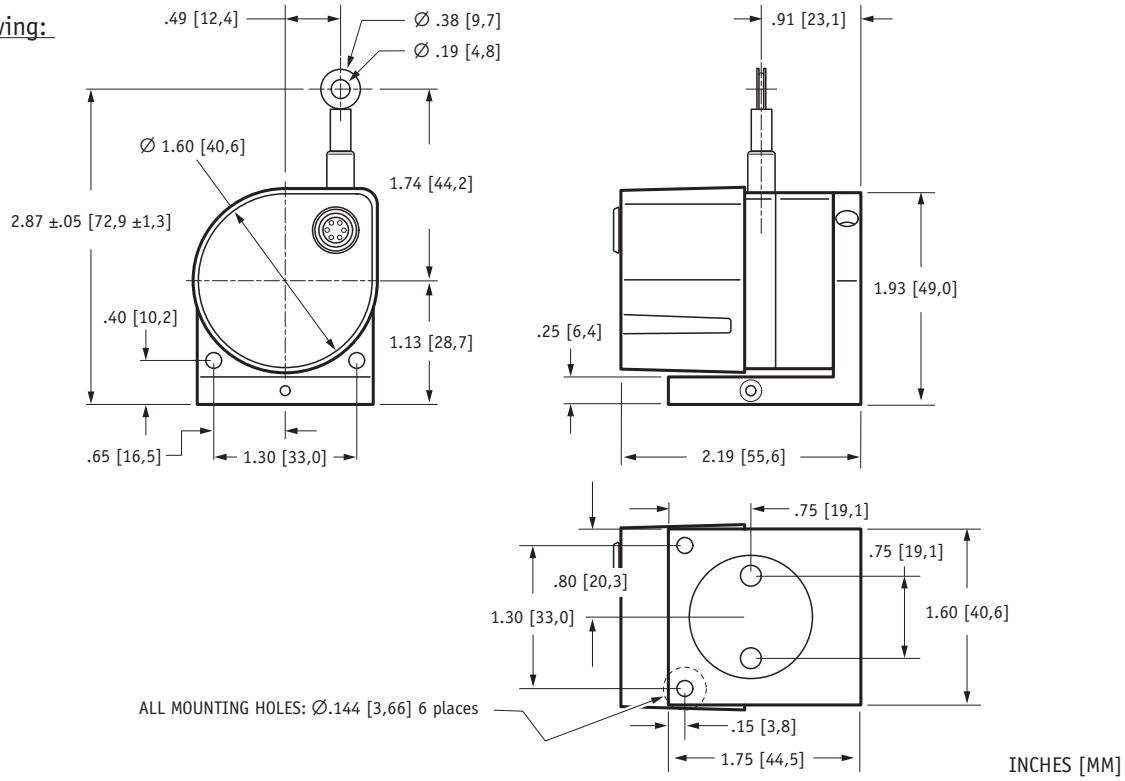

**Ordering Information:**

**Model Number:**

**MT2E - 30 - - 316 -**  
*order code:*      **A**      **B**      **C**

Sample Model Number:

**MT2E - 30E - 33 - 316 - M1**

- R** range: 30 inches
- A** measuring cable termination: eyelet
- B** measuring cable tension: 33 oz. (±6 oz.)
- C** electrical connection: end-mounted connector

**Measuring Cable Termination:**

**A** *order code:*

**E**

Eyelet

**L**

Leader Cable (24 in. long)

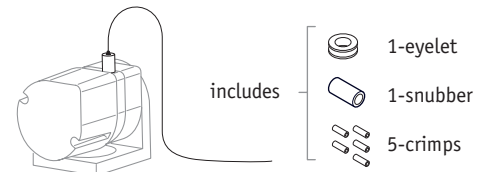
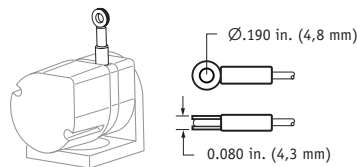

**Measuring Cable Tension:**

**B** *order code:*

	<b>9</b>	<b>14</b>	<b>33</b>
tension:	9 (±2) oz.	14 (±4) oz.	33 (±6) oz.
max. cable acceleration:	99 g	136 g	136 g
spring cycle-life, 25-inch extension:	≥ 1 million	150,000	75,000
spring cycle-life, 15-inch extension:	≥ 1 million	≥ 1 million	≥ 1 million

Ordering Information (cont.):

**Electrical Connection:**

order code:	M1	M2	M3	C1	C2	C3
connection:	end-mount connector	side-mount connector	top-mount connector	end-mount strain relief	side-mount strain relief	top-mount strain relief
available channels:	A, B	A, B	A, B	A, A', B, B'	A, A', B, B'	A, A', B, B'

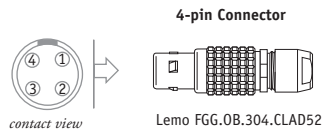
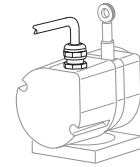
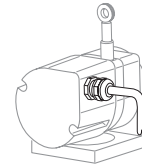
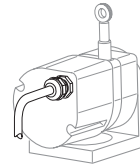
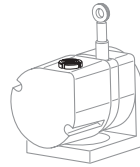
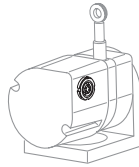
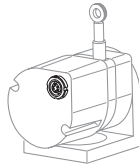

pin#	signal
1	input voltage (V+)
2	common (gnd.)
3	channel A
4	channel B

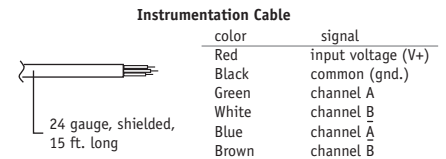

Accessories:

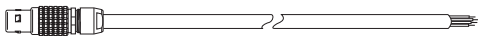

Part Number	Description
9603957-0015	15 ft. long cordset. Includes mating connector with 15 ft., 24 gauge, shielded multiconductor cable

北京赛斯维测控技术有限公司  
 北京市朝阳区望京西路48号  
 金隅国际C座1002  
 电话：+86 010 8477 5646  
 传真：+86 010 5894 9029  
 邮箱：[sales@sensorway.cn](mailto:sales@sensorway.cn)  
<http://www.sensorway.cn>

version: 5.1 last updated: April 15, 2013